



SPECIFICATION

<b>Customer Name</b>					
<b>Customer No.</b>					
<b>Product Description</b>			<b>3804 SIDE VIEW WHITE LED</b>		
<b>Product Model</b>			<b>OR-PL010W</b>		
<b>Orient Confirm</b>			<b>Customer Confirm</b>		
<b>Approved by</b>	<b>Checked by</b>	<b>Prepared by</b>	<b>Approved by</b>	<b>Quality</b>	<b>Engineering</b>
Chenjun yuan	Linshixiu	Haijun Huang			
<b>Judge outcome:</b>		<b>OK</b>	<b>Judge outcome:</b>		



Add: Building 1,21 Jinhui Road, Jianghai district, Jiangmen

TEL: +86-0750-3697838

URL: www.orient-opto.com



## 1、 Features

- Package: 3.8\*0.9\*0.43mm
- Emitted colour:White
- Soldering methods:SMT assembly available
- RoHS compliant & Pb free



## 2、 Applications

- LCD backlight
- Decoration lighting
- Mobile phone, panel computer backlight

## 3、 Package Outline Dimensions

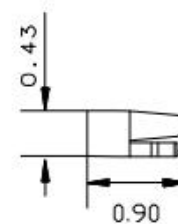
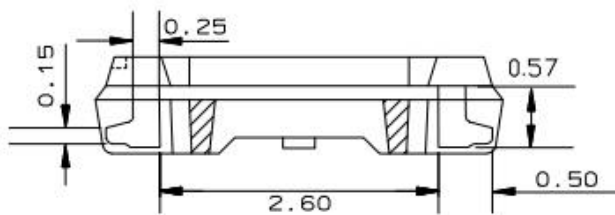
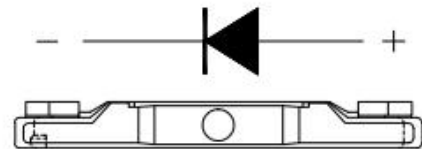
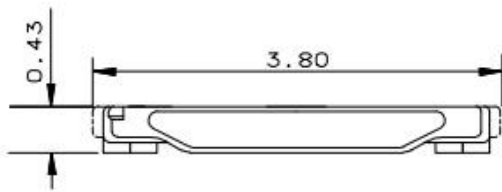

Recommended soldering pad design

### Notes:

The tolerances unless mentioned are  $\pm 0.1$ mm, unit = mm.



### 4、 Absolute maximum ratings at Ta=25°C

Parameter	Symbol	Typical	Unit
Power dissipation	Pd	100	mw
Forward current	If	30	mA
Reverse voltage	Vr	5	V
Operating temperature range	Top	-40 ~+85	°C
Storage temperature range	Tstg	-40~+100	°C
Peak pulsing current	Ifp	100	mA
Electrostatic Discharge	ESD	2000(HBM)	V
Soldering temperature	Tsld	Reflow Soldering:260°C for 10 secs Hand Soldering: 350°C for 3 secs	

\*IFP Conditions: Pulse Width  $\leq$  10msec. and Duty cycle  $\leq$  1/10.

### 5、 Electrical-optical characteristics at Ta=25°C

Parameter	Test Condition	Symbol	Min.	Typ.	Max.	Unit
Forward voltage	If=20mA	Vf	2.8	--	3.4	V
Luminous intensity	If=20mA	IV	2500	--	--	mcd
CIE Chromaticity	If=20mA	X	--	--	--	--
	If=20mA	Y	--	--	--	--
Viewing angle	If=20mA	2 $\theta$ 1/2	--	120	--	Deg
Reverse current	Vr=5V	IR	--	--	10	UA

Notes:

- 1、 Tolerance of luminous intensity is  $\pm 5\%$ .
- 2、 Tolerance of forward voltage is  $\pm 0.05V$ .



## 6. Typical optical characteristics curves

Relative intensity VS. Wavelength

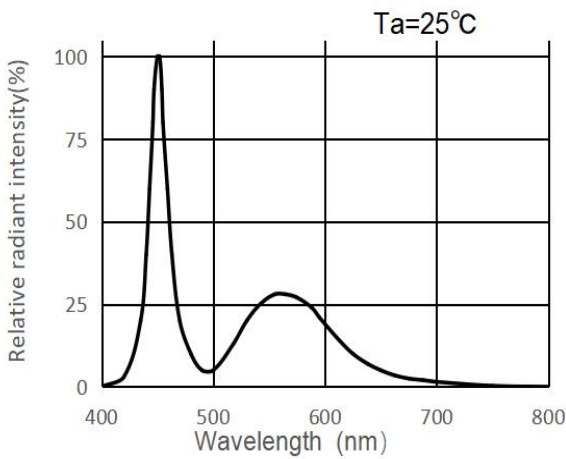

Directivity (Angle : 120°)

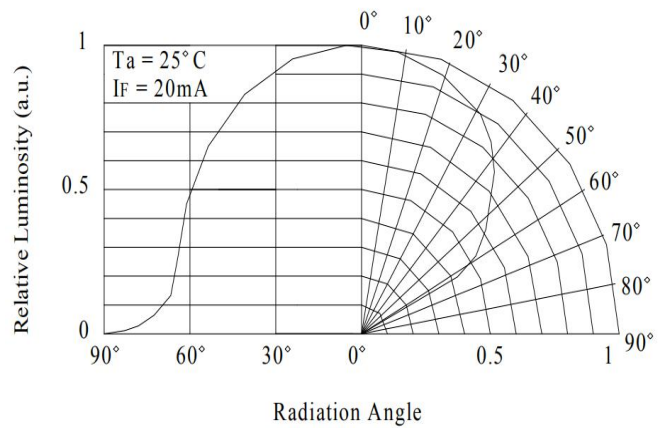

Forward Current vs. Forward Voltage

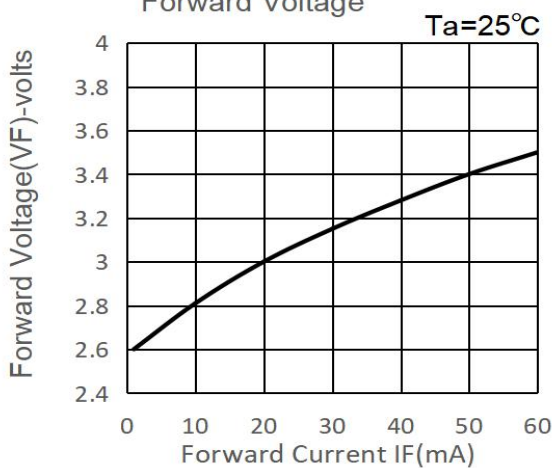

Forward Current vs. Relative Luminous Intensity (%)

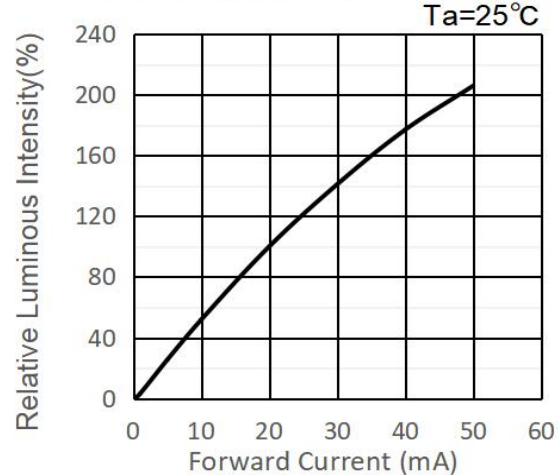

Ambient Temperature vs. Chromaticity Coordinate

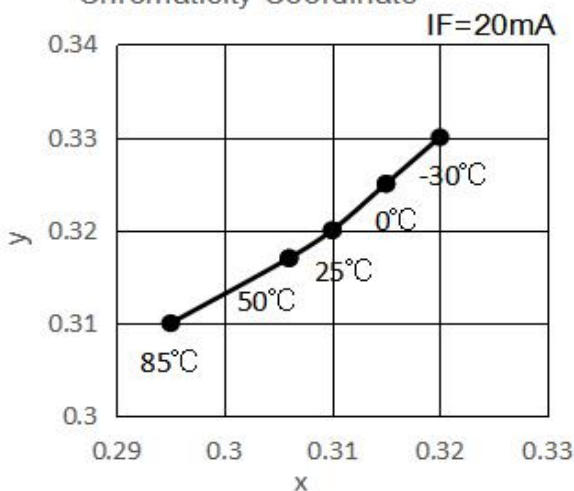

Forward Current vs. Chromaticity Coordinate

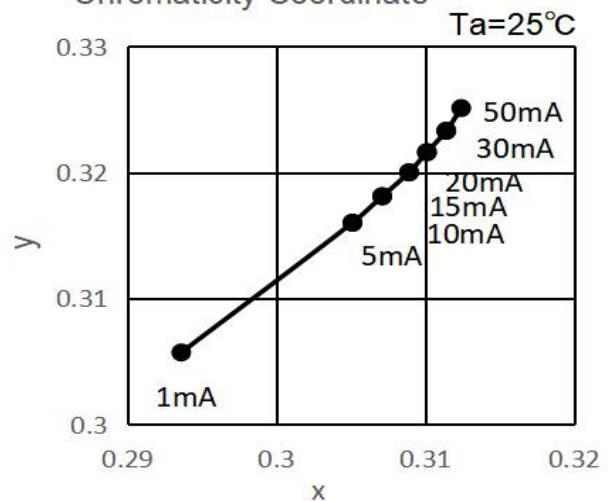



## 7、CIE Chromaticity Diagrams

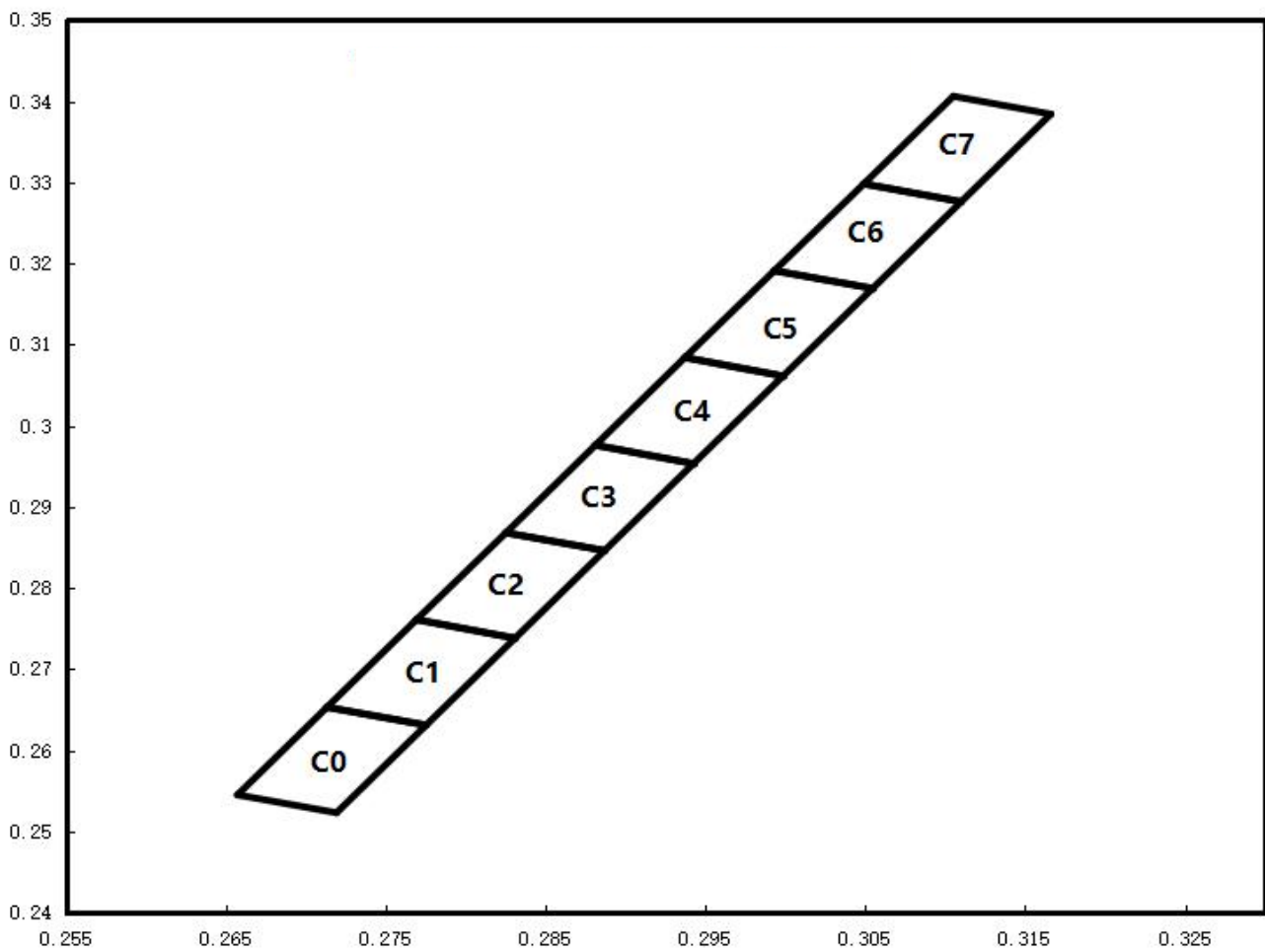



8、Color Ranks(IF=20mA,Ta=25°C)

BIN Code	X	Y	BIN Code	X	Y	BIN Code	X	Y
C0	0.2719	0.2523	C1	0.2775	0.2631	C2	0.2831	0.2738
	0.2657	0.2545		0.2713	0.2653		0.2769	0.2761
	0.2713	0.2653		0.2769	0.2761		0.2825	0.2868
	0.2775	0.2631		0.2831	0.2738		0.2887	0.2846
C3	0.2887	0.2846	C4	0.2943	0.2953	C5	0.2999	0.3061
	0.2825	0.2868		0.2881	0.2976		0.2937	0.3084
	0.2881	0.2976		0.2937	0.3084		0.2993	0.3191
	0.2943	0.2953		0.2999	0.3061		0.3055	0.3169
C6	0.3055	0.3169	C7	0.311	0.3276			
	0.2993	0.3191		0.3049	0.3298			
	0.3049	0.3298		0.3105	0.3406			
	0.311	0.3276		0.3166	0.3384			

Notes:

- 1、 Measurement uncertainty of the color coordinates:±0.01.



## 9、 Light Intensity rank and bin code (IF=20mA,Ta=25°C)

20mA test				
CODE	Min.(mcd)	Max.(mcd)	Min.(lm)	Max.(lm)
27A	2700	2800	6.00	6.25
28A	2800	2900	6.25	6.50
29A	2900	3000	6.50	6.75
30A	3000	3100	6.75	7.00
31A	3100	3200	7.00	7.25
32A	3200	3300	7.25	7.50
33A	3300	3400	7.50	7.75
34A	3400	3500	7.75	8.00
35A	3500	3600	8.00	8.25
36A	3600	3700	8.25	8.50
37A	3700	3800	8.50	8.75
38A	3800	3900	8.75	9.00

Notes:

- 1、 Tolerance of luminous intensity is  $\pm 5\%$ .

## 10、 Forward voltage rank and bin code(IF=20mA,Ta=25°C)

20mA test					
CODE	Min.(V)	Max.(V)	CODE	Min.(V)	Max.(V)
V1	2.8	2.9	V4	3.1	3.2
V2	2.9	3.0	V5	3.2	3.3
V3	3.0	3.1	V6	3.3	3.4

Notes:

- 1、 Tolerance of forward voltage is  $\pm 0.05V$ .

## 11、Packaging Specification

●Dimensions for Reel (Unit: mm)

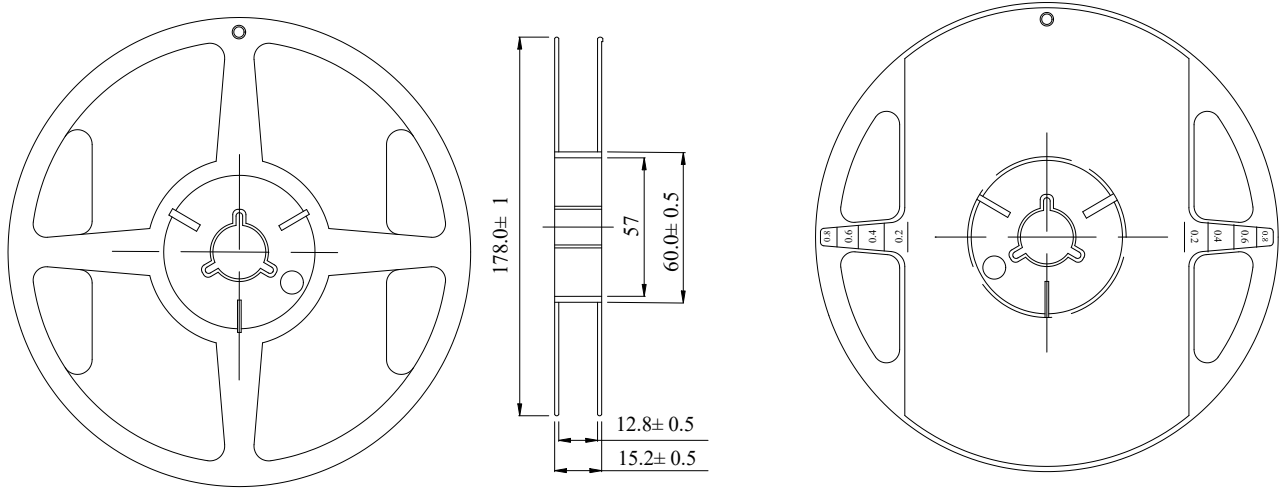

●Dimensions of Tape (Unit: mm)

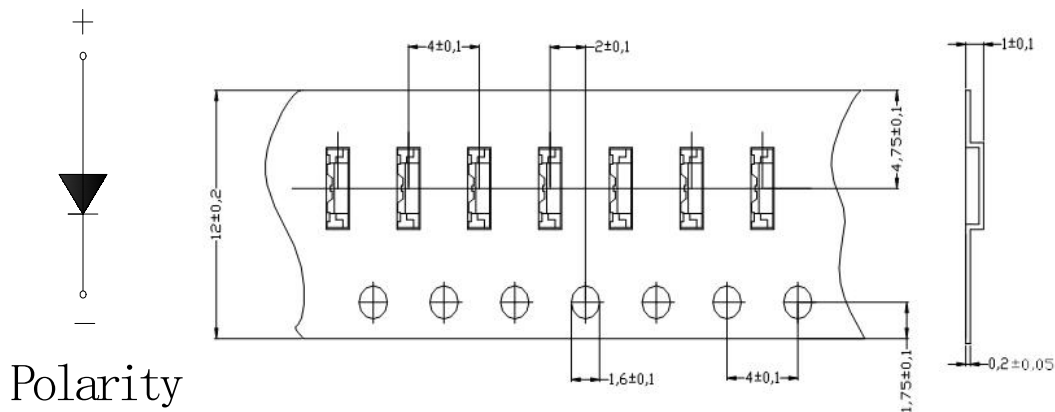

Notes:

- 1、 All dimensions are in mm, tolerance is  $\pm 2.0$ mm unless otherwise noted.
- 2、 Specifications are subject to change without notice.
- 3、 Loaded quantity: 5000 pcs/reel.





## 12、 Label description

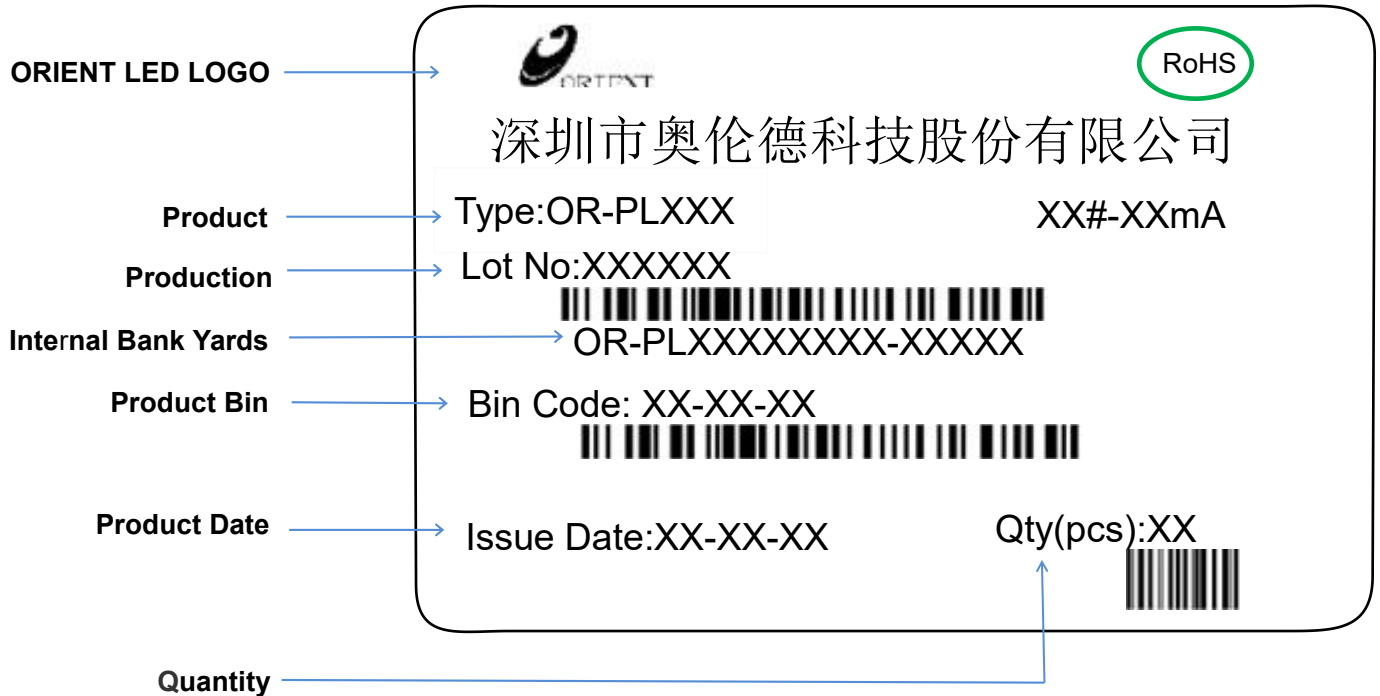

### ●BIN description: X - X - X

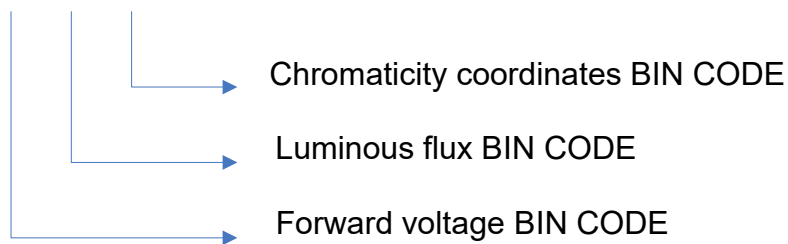



### 13、Reliability Test Items and Conditions

Test Item	Test Conditions	Test Hours / Times	Number of sample	Ac/ Re	Criteria	
					$\Phi@$ 20mA	VF@ 20mA
Reflow Soldering	260°C (Max.), within 10seconds. (Max.)	3 times	0/20	0/1	<±10%	<±10%
Temperature cycle	-40°C 30min ↑↓25°C(5min) 100°C 30min	100 cycles	0/20	0/1		
Thermal Shock	-40°C 30min ↑↓ 5sec 100°C 30min	100 cycles	0/20	0/1		
Humidity Heat Storage	Ta=85°C RH=85%	1000 hours	0/20	0/1	> 70%	< 110%
High Temperature Storage	Ta=100°C	1000 hours	0/20	0/1		
Low Temperature Storage	Ta=-40°C	1000 hours	0/20	0/1		
Room Temperature Test	Ta=25°C IF=20mA	1000 hours	0/20	0/1		

Notes:

- 1、 Measurement shall be taken within 2 hours.
- 2、 The tested LED have been returned to normal ambient conditions before testing.



## 14、Precautions for use

### 1、Soldering

SMD LED encapsulation is very flexible, outside force easily demolish radiant surface and plastic, As soldering, Please handle with care!

1.1. With No-clean Flux, according to reflow soldering cure condition when soldering, Reflow soldering should not be done more than two times, simultaneity you must insure clean on the radiant surface. Otherwise, foreign objects can affect radiant color.

1.2. Don't process manual soldering except repair. Recommended to be soldered with 25W Anti-static iron, The temp. of the iron should be lower than 300°C and soldering time should not be done more than three seconds, at the same time iron can't touch radiant surface and plastic.

1.3. Don't twist LED in course of manual soldering and experiment, otherwise, the lights will not work possibly.

1.4. Please use the same BIN grade in one panel, and don't mix the difference BIN grade in one panel when soldering. Otherwise, it will cause a serious uneven color problem.

1.5. Please control the sulfur content of solder paste and PCB.

1.6. Pb-free solder temp.-time profile as below:260°C Max

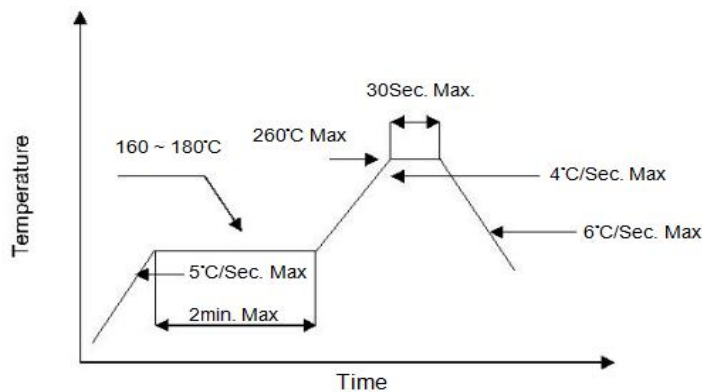

### 2、Cleaning

2.1. Don't be cleaned with ultrasonic. Recommended to be wiped with isopropyl alcohol or pure alcohol, wiping time should not be more than one minute. LED must be placed at room temperature for fifteen minutes before using. After cleaning, you must insure clean on the radiant surface. Otherwise, foreign objects can affect radiant color.

2.2. LED can not be in contact with isoamyl acetate, trichloroethylene, acetone, sulfide, nitride, acid, alkali, salt. These matter can destroy LED.

### 3、Sealing

3.1. Sealing glue can not contain sodium ion, sulfide, because these matter can affect fluorescence powder poisoning.

3.2. When using normal sealing glue, Recommended to be operated life for 168hrs under normal temperature.

### 4、Storage

4.1. Don't open the moisture proof bag before ready to use the LEDs.

4.2. The LEDs should be kept at 30°C or less and 60%RH or less before opening the package. The max. storage period before opening the package is 1 year.

4.3. After opening the package, the LEDs should be kept at 30-35%RH or less, and it should be used within 3 days. If the LEDs should be kept at 30-35%RH or more, and it should be used within 4 hours.

4.4. If the LEDs be kept over the conditions of 20%, baking is required before mounting. Baking condition as below: 70±5°C for 12 hrs for bulk goods, 105±5°C for 1 hrs for roll goods.

4.5. The environment have no acid, alkali, corrosive gas, intensively shake and high magnetic field.

### 5、 Static

5.1. Static and Peak surge voltage can destroy LED, Avoiding Instantaneous voltage when turn on or turn off the lights.

5.2. Please wear Anti-static wrist band, Anti-static glove, Anti-static shoes in the course of operation, and the equipment must be grounded.

### 6、 Test

6.1. Customer must apply the current limiting resistor in the circuit so as to drive the LEDs within the rated current. Otherwise slight voltage shift maybe will cause big current change and burn out will happen.

6.2. Also, caution should be taken not to overload the LEDs with instantaneous high voltage at the turning ON and OFF of the circuit. Otherwise, The LEDs will be destroyed, testing methods as follows:

6.3. The reverse voltage mustn't exceed 5v when lighting on or testing the LED, otherwise, The LEDs will be damaged.

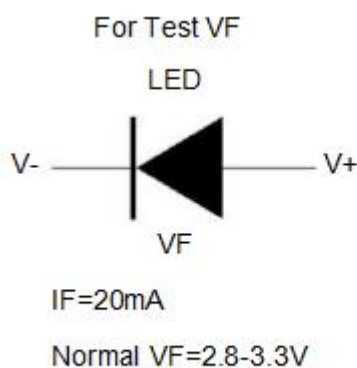

**Fig.1**

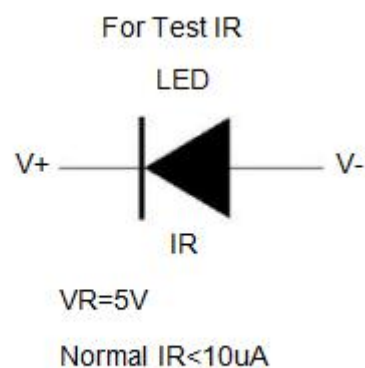

**Fig.2**

### 7、 Else

Radiant color of LEDs have a little change with the current, recommended that LED is used in series and resistance, when lighting, please don't see directly radiant surface of LED, otherwise LED will burn eyes.